



Delfield®

UC4427N UNDERCOUNTER

Front-Breathing Undercounter Refrigerators

Project _____

Item _____

Quantity _____

CSI Section 11400

MODELS:

UC4427N

Single section refrigerator
Under counter with doors

UCD4427N

Single section refrigerator
Under counter with drawers



Model UC4427N



STANDARD FEATURES

- All 4400 and 4500 Series units are 100% front breathing, which allows the unit to be pushed against a wall or built into a cabinet or an existing line up
- Durable, rugged stainless steel sides, top and front
- Features Delfield's exclusive ABS interior (on sides). ABS is extremely durable - it won't dent, chip or corrode and is backed by a limited lifetime warranty
- Heavy duty self-closing hinges
- "D" prefix models feature Delfield's exclusive new drawer system. Drawers are backed by a 10-year warranty on the track assembly
- Environmentally friendly R404A refrigerant
- High density foamed in place polyurethane keeps energy costs low
- Black recessed quick grip handle
- Standard on 2" casters for easy cleaning and installation
- 60-cycle single phase electrical system
- 7' cord and plug supplied
- One epoxy coated wire shelf standard, installed per door section
- ACT solid state electronic control
- One year parts and 90 day labor standard warranty.

OPTIONS AND ACCESSORIES

- Flat lift off cover
 - 18" wide single tier overshell
 - Stainless steel finish on back
 - Plastic laminate on front
 - Additional wire shelves
 - Door lock
 - Exterior thermometer
 - Interior lights
 - Glass door(s)
 - *220V/50 Hertz electrical system
- *Inclusion of this option will alter electrical specifications of the unit.

SPECIFICATIONS

Exterior top is one-piece, 22-gauge stainless steel with integral square nosing on the front.

Exterior back and bottom are two-piece 24-gauge galvanized steel.

Exterior ends are stainless steel.

Interior sides of door models are thermoformed ABS plastic with integral shelves supports. Interior back is one-piece 22-gauge stainless steel. Interior bottom and top are thermoformed ABS plastic. Base is fully insulated with high-density foamed in place polyurethane.

Refrigeration system uses HFC-404A refrigerant. Compressor is 1/5 H.P., with condenser coil and condensate evaporator mounted on rear of the cabinet. Evaporator coil are located on the interior rear wall of

the cabinet. Refrigerant flow is controlled by a capillary tube. Cabinet maintains an interior cabinet temperature of 36°F to 40°F (2°C to 4°C).

ACT control. ACT electronic, solid state control, mounted on the exterior rear of the cabinet, allows unit to maintain precise temperatures in heavy duty conditions.

Electrical connections are 115 volt, 60 Hertz, single phase. Unit has a 7' (2.1m) long electrical cord and NEMA 5-15P plug.

Casters: Equipment is mounted on 2" (5.08cm) diameter front locking plate casters. 2.5" (6.35cm) ride height.

Doors have a 24-gauge stainless steel exterior, with thermoformed ABS plastic interior liner. Cabinet of door models has one adjustable epoxy-coated wire shelf.

Drawers have a 24-gauge stainless steel exterior with thermoformed ABS plastic interior liner. Drawer frames are 12-gauge stainless steel. Drawer slides are 11-gauge stainless steel with Delrin bearings. Drawer units have two drawers. Top drawer holds one 12" x 20" (30.5cm x 50.8cm) and three 1/6 size 4"-6" (10.2cm-15.2cm) deep pans. Bottom drawer holds one 12" x 20" and three 1/6 size 4" deep pans. Pans are supplied by others.

UC4427N FRONT-BREATHING UNDERCOUNTER REFRIGERATORS



980 S. Isabella Road
Mt. Pleasant, MI 48858
www.delfield.com

Phone: 800-733-8948
Fax: 800-669-0619
Email: info@delfield.com

Approval _____

Date _____

UC4427N Front-Breathing Undercounter Refrigerators

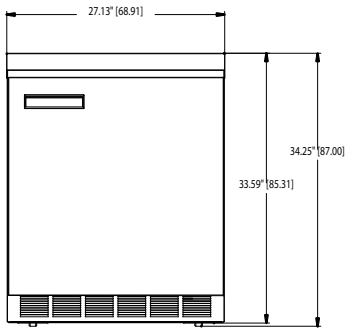

UC4427N ELEVATION VIEW

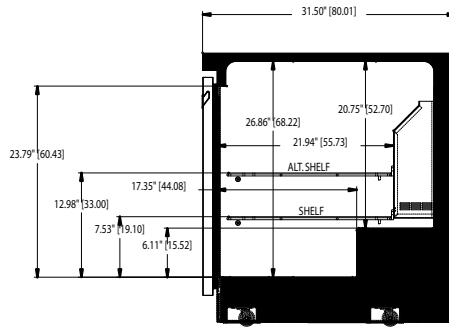

UC4427N RIGHT SIDE VIEW

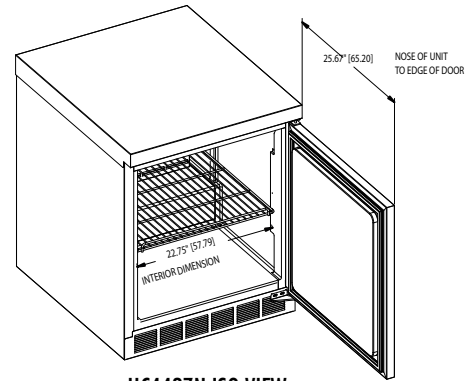

UC4427N ISO VIEW

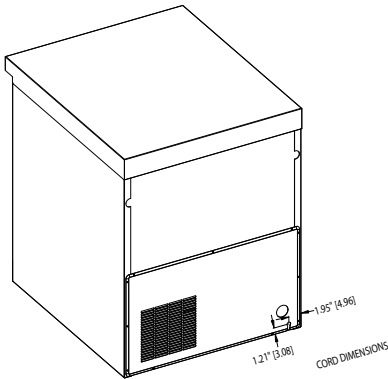

UC4427N & UCD4427N
REAR ISO VIEW

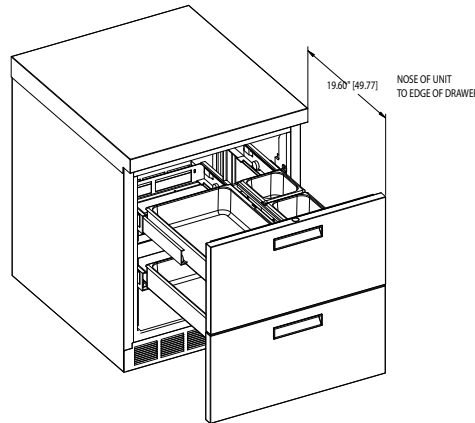

UCD4427N ISO VIEW

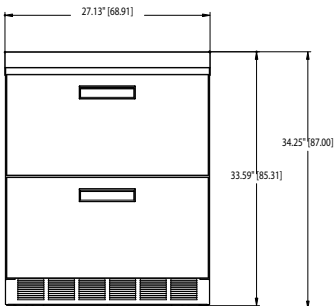

UCD4427N ELEVATION VIEW

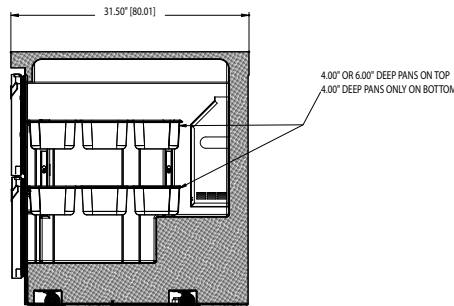

UCD4427N RIGHT SIDE VIEW

INSTALLATION NOTE:

Refrigeration system is designed so that air will flow under the unit, through the compressor area and out the front of the unit. Any restriction to this air flow path will void the warranties.

PLEASE NOTE:

Air flow through the louver on the back of the unit is not necessary for operation, however, any air which passes through the louver is beneficial.

Mechanical Data - Standard Unit

MODEL NUMBER	# OF SHELVES	SHELF AREA SQ.FT.	STORAGE CAP. CU.FT.	H.P.	VOLTS/HERTZ/PHASE	AMPS	NEMA PLUG	SHIP WEIGHT
UC4427N	1	3.20	5.7	1/5	115/60/1	7.2	5-15P	220LBS./100KG.
UCD4427N	NA	NA	1.5	1/5	115/60/1	7.2	5-15P	265LBS./120KG.